



春雨工廠 股份有限公司
CHUN YU WORKS & CO., LTD.
 www.chunyu.com.tw

春雨集團企業總部

高雄市82063岡山區大寶街100號
 TEL: 886-7-622-4111 FAX: 886-7-621-6697
 http://www.chunyu.com.tw
 E-mail: sales@chunyu.com.tw

台北分公司

台北市10363承德路三段132號
 TEL: 886-2-2592-5161 FAX: 886-2-2595-9912
 E-mail: sales@chunyu.com.tw

春雨(東莞)五金制品有限公司

廣東省東莞市523795大朗鎮松木山永豐管理區
 TEL: 86-769-83310921 FAX: 86-769-83181001/83180094
 http://www.chunyu.com.cn

春雨(鞍山)五金制品有限公司

遼寧省鞍山市達道灣工業區汽摩配產業園
 TEL: 86-412-7265999 FAX: 86-412-7265599

上海友鉅五金制品有限公司

上海市200949寶山區羅涇鎮民營路5號
 TEL: 86-21-66877022 FAX: 86-21-66877012
 http://www.uchee.com.cn
 E-mail: sales@sh-uchee.com

春雨工廠美國公司

1037 Walnut Avenue Pomona, CA 91766, USA.
 TEL: 01-909-627-7070 FAX: 01-909-627-6255
 http://www.cywusa.com

印尼雄獅工業股份有限公司

Jl. Rawa Bali / No.8 Industrial Estate Pulogadung,
 Jakarta 13920, Indonesia.
 TEL: 62-21-4602888 FAX: 62-21-4602887

GROUP HEADQUARTER

100, Tapao St., Kangshan Dist, Kaohsiung 82063, Taiwan.
 TEL: 886-7-622-4111 FAX: 886-7-621-6697
 http://www.chunyu.com.tw
 E-mail: sales@chunyu.com.tw

TAIPEI BRANCH

132, Chen Teh Rd., Sec. 3, Taipei 10363, Taiwan.
 TEL: 886-2-2592-5161 FAX: 886-2-2595-9912
 E-mail: sales@chunyu.com.tw

CHUN YU (DONGGUAN) METAL PRODUCTS CO., LTD.

Yon Fong Industry Park, Song Mu Shan Section, Dalang,
 Dongguan 523795, Guangdong, China.
 TEL: 86-769-83310921 FAX: 86-769-83181001/83180094
 http://www.chunyu.com.cn

CHUN YU (ANSHAN) METAL PRODUCTS CO., LTD.

Dadaowan Automobile Accessories Industrial Park, Anshan City,
 Liaoning Province, China.
 TEL: 86-412-7265999 FAX: 86-412-7265599

SHANGHAI UCHEE HARDWARE PRODUCTS CO., LTD.

No.5, Minying Rd., Luojing Town, Baoshan District,
 Shanghai City 200949, China.
 TEL: 86-21-66877022 FAX: 86-21-66877012
 http://www.uchee.com.cn
 E-mail: sales@sh-uchee.com

CHUN YU WORKS (U.S.A.) INC.

1037 Walnut Avenue Pomona, CA 91766, USA.
 TEL: 01-909-627-7070 FAX: 01-909-627-6255
 http://www.cywusa.com

PT. MOON LION INDUSTRIES INDONESIA

Jl. Rawa Bali / No.8 Industrial Estate Pulogadung,
 Jakarta 13920, Indonesia.
 TEL: 62-21-4602888 FAX: 62-21-4602887



春雨工廠
CHUN YU WORKS



Since 1949

CHUN YU GROUP
Corporate Profile



CONTENTS

目錄

- 02** 營業項目
BUSINESS ITEMS
- 03** 經營理念
CORPORATE PHILOSOPHY
- 04** 產品介紹與應用
PRODUCT APPLICATIONS
- 12** 工廠設備
EQUIPMENT & FACILITIES
- 15** 研究發展與資訊管理
R&D AND INFORMATION SYSTEM MANAGEMENT
- 16** 品質保證
QUALITY ASSURANCE
- 19** 客戶群
CUSTOMER
- 20** 客戶實績
ACHIEVEMENT
- 22** 公司簡介
COMPANY PROFILE
- 25** 組織架構圖
ORGANIZATIONAL CHART
- 26** 關係企業
SUBSIDIARIES & AFFILIATES
- 28** 公司沿革
SIGNIFICANT EVENTS



SMALL BUT POWERFUL

小零件 · 大力量

鋼結構 | 建築 | 重工業
Steel Structure / Construction / Heavy Industry



EN 14399-1 (8.8 or 10.9HR;
10.9HV; 10.9HRC)
EN 15048-1 (8.8SB)

JIS B 1180
JIS B 1176

經營理念

CORPORATE PHILOSOPHY

春雨公司在台灣的螺絲、螺帽製造業中享有優良的信譽，是因為全體員工不斷地努力與客戶的支持所累積而來，我們願意輝煌的成就分享給愛護我們的各界新進朋友。春雨的經營政策就是「製造業服務化」，提供最佳品質產品、最具競爭的價格和最佳服務，以分享給我們的顧客、員工、股東和社會大眾。

Chun Yu owns a high reputation among fastener industry in Taiwan which accumulated by our employees' efforts and customers' support. We are willing to share our significant achievements to those who supported us. "Servitization" has always been Chun Yu's corporate policy; therefore, we provide the best quality, the most competitive price and superior services to feedback our customers, employees, shareholders and the public.



營業項目

BUSINESS ITEMS

螺絲、螺帽、攻牙

Bolts, Nuts and Self-Tapping Screws

汽機車、自行車用組扣件

Automotive Fasteners

鐵道系統組扣件

Railway System Fasteners

建築用緊固件

Construction and Building Fasteners

鋼結構組扣件

Steel Structure Fasteners

電子用扣件

Electronic Fasteners

工業及機械用緊固件

Heavy Industry and Machinery Fasteners

航太扣件

Aerospace Fasteners

綠能扣件

Green Energy Fasteners

鍊帶螺絲、鍊帶槍製造買賣

Collated Screw and Autofeed Screwdriver

冷拉捲線、球化鋼材製造

Cold Drawn Wire and Annealing Wire

磨光鋼棒、盤元製造買賣

Bright Steel Bar and Wire Rod

產品加工、表面處理

Surface and Phosphating Treatment

鋼鐵、機械及工具製造買賣

Steel, Machine and Tooling

廢棄物處理

Waste Treatment System

防治污染工程

Environmental Protection Engineering



ALWAYS BEEN PART OF YOUR LIFE

永遠是您重要的一部份

鐵道系統組件
Railway System



產品介紹與應用 PRODUCT APPLICATIONS

在人類生活文明中，從大至飛機、高鐵、捷運等各類交通工具、設備到電腦、家電等生活製品，螺絲的用途幾乎無所不在，與人類生活息息相關。春雨公司致力於各式螺絲、螺帽和攻牙螺絲、球化線材的製作、甚至到系統運用組件製造，配合高超的技術和嚴密的製程品管，提供您所需要的各種製品與服務。

Chun Yu provides product diversification and various services from large transportations like airplane, MRT and high speed rail to home electronics such as computers and electronics by our design techniques and comprehensive quality control ability. We devote ourselves to manufacturing bolts, nuts, self-tapping screws, annealing wire, and the system components package for railway together with superior technique and precise quality control to provide wide range of products and services.





CUSTOMIZED

量身訂做 · 滿足需求

汽車扣件
Automotive



產品介紹與應用 PRODUCT APPLICATIONS

春雨公司的營業範圍兼具廣度與深度，能為您量身訂做和生產高難度的螺絲等相關製品，解決您製造上的問題，永遠以滿足您的需求為上，作為春雨進步的驅動力。春雨不以現況自滿，不斷的自我挑戰，與您一起成長，我們有自信是您事業上值得信賴的打拼夥伴。

With Chun Yu's superior services, the products can be customized according to customer's order together to achieve, consult and solve any technical difficulty with special requirement. In addition, with the continuous challenges that enable us to enhance professional level and competitiveness over the industry.





ACTION/SOPHISTICATE/ NEW OPPORTUNITY

行動 · 尖端 · 新契機

航太扣件
Aerospace



精密儀器 | 電子資訊設備
Precision Instrument / Electronics



腳踏車
Bicycle



JIS B 1180
JIS B 1176

產品介紹與應用 PRODUCT APPLICATIONS

春雨公司一路走來秉持著刻苦自動的精神，不斷研發及改良產品品質、提高產品附加價值。開發腳踏車配件，在行動上提供更安全的一層保障；發展航太科技，於尖端精密的儀器設備上更顯可靠。春雨的努力已在日常生活、工作中成為不可或缺的一環，未來仍會與時增進，再創螺絲產業新契機。

Chun Yu devotes itself in continuous research and development to quality improvement and value-added of the products. Considering the better security of the bicycle parts to mobility improvement, and the reliability of the precision instruments to aerospace technology we develop the highly sophisticated products to provide the needs and become the indispensable parts in daily life and work to create the new opportunities for fastener industry.



機械設備
Machinery & Equipment

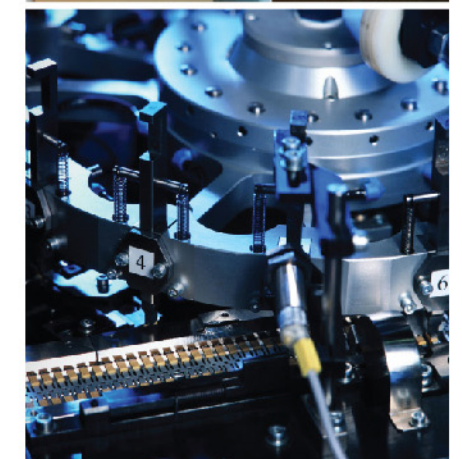
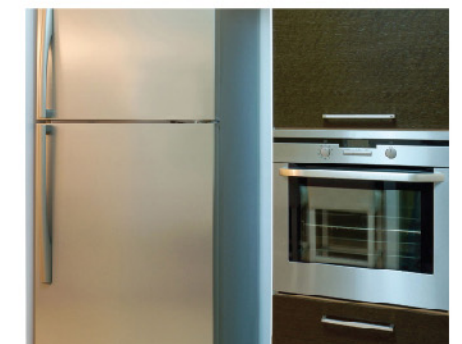



EFFICIENCY PURSUITS BENEFITS



效率追求效益

鍊帶槍 · 工具組件
Collated Autofeed Screwdriver

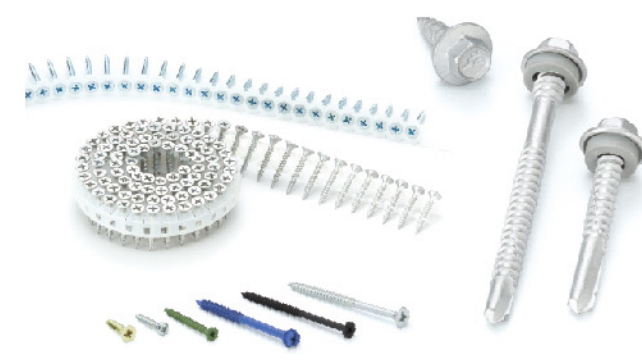

鍊帶螺絲 | 室內裝潢 | 房屋修繕
Collated Screw / Housing



CE  151823  C US
EN 14566:2008+A1:2009
EN 14592:2008+A1:2012

產品介紹與應用 PRODUCT APPLICATIONS

從不斷服務客戶經驗中汲取市場需求，春雨公司從基本的螺絲，進而提供增值性的鍊帶螺絲產品來服務客戶，為進一步幫助客戶拓展銷售及整合服務，春雨公司更推出物廉價美配套的鍊帶槍組件，為客戶與春雨雙方共同創造雙贏局面。

Chun Yu provides various services toward customer from the basic screws to value-added collated screw products by understanding the needs of market through the experiences of continuously serving the customers. Even then we offer the complete set of competitive gear in collated autofeed screwdriver to favor our customer in order to boost customers' growth of sales as well as to achieve the mutual win for both.

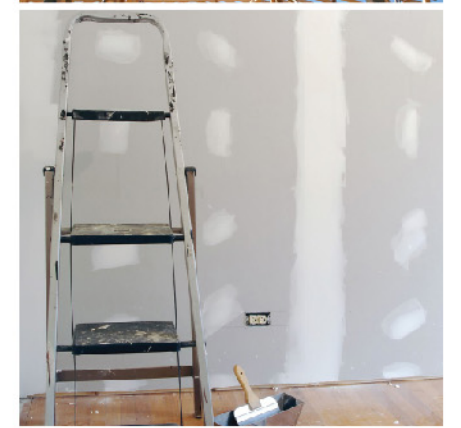



ADVANCED FACILITIES & PRODUCT EFFICIENCY

先進的機器設備 · 效率的製造生產

工廠設備 EQUIPMENT & FACILITIES

本公司擁有一貫化流程生產設備，從酸洗、球化、伸線、精伸等材料加工，多採用電腦控制自動化生產，以求材料品質穩定性。為增加螺絲、螺帽等產品外型與尺寸選擇的多樣性，則增購六模六沖成型機台、熱打成型機。龐大攻牙產能，能配合客戶需求彈性調度生產。

Chun Yu has an integrated production process which is auto-controlled by computers to ensure the stable quality of materials. In order to diversify the type and size of Bolts and Nuts products, we acquired the six-die six-station forming machine and hot nuts forming machine. Our massive capability of tapping screws always manages to meet our customers' needs and productivity adjustment.

螺絲工場
五沖螺絲零件成型機
The Bolts Plant
5 Dies Bolts & Part Former

螺帽工場
The Nuts Plant
伸線工場
The Wire Drawing Plant

球化工場
The Annealing Plant
光學篩選機
Optical Sorting Machine

真空燒結爐
Vacuum Sintering Furnace
包裝與倉儲
Packaging & Inventory



12 自動化酸洗工場
The Automatic Pickling System



CORPORATE SOCIAL RESPONSIBILITY & ENVIRONMENTAL PROTECTION

企業社會責任表現 · 污染防治系統提升

工廠設備 EQUIPMENT & FACILITIES

春雨對地球環境保護不遺餘力且善盡社會責任，除必要之污染防治設施，更耗費鉅資增設螺絲界僅有的一套廢酸回收處理設備，使廢鹽酸99%回收再利用，春雨降低資源損耗作法，更進一步取得ISO-14001環境管理認證。

Chun Yu has made great efforts in Green Programs, Corporate Social Responsibility, and Environmental Protection. Chun Yu is the only one fastener manufacturer in Taiwan who owns acid treatment system. This system recycles the waste acid from annealing and pickling process with a 99% recycling rate which enables the continuous usage of resources. Furthermore, Chun Yu awarded with ISO 14001 Environmental Management System Certificate.

廢酸回收工場
Acid Treatment System



CONTINUOUS RESEARCH & DEVELOPMENT

永續研發 · 聰明管理

研究發展與資訊管理 R&D AND INFORMATION SYSTEM MANAGEMENT

技術人員發揮專業技術，將客戶委託製造的產品及品質產出達到一流水準。客戶亦可將應用狀況或想法，透過春雨研發人員專業設計，產出符合實際需求的產品，充分地展現本公司ODM的精神。春雨公司資訊系統配合科技進步，更新生產、銷售、人事、財務系統使其更有效率及人性化，更導入PDM（產品資料庫）與企業間電子化系統，全面將研發與客戶服務納入資訊系統，使整體管理更Smart。

With our professional technicians enable the products meet customer's requirements and different applications towards the ODM spiritually. Through our user-friendly information system, which allow us easily update the data of production, sales, personnel, finance etc. efficiently. We have conducted Product Data Management (PDM) and electronic system among the related industry and brought R&D as well as customer service into our information system toward more efficient and smart management.

管銷全面電腦化
Adopted Electronic System

2D 3D原型建構
2D 3D Molding

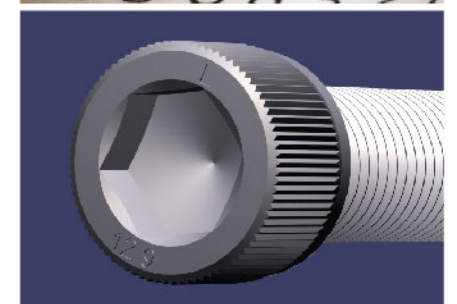



EN 14399-1 (8.8 or 10.9HR; 10.9HV; 10.9HRC)
 EN 15048-1 (8.8SB)
 EN 14566:2008+A1:2009
 EN 14592:2008+A1:2012
 EN ISO 13918

JIS B 1180
 JIS B 1176

多項國際認證
 International Certificates



SERVING SOCIETY WITH THE BEST QUALITY

以最好的品質來服務社會

品質保證 QUALITY ASSURANCE

我們優良的製品品質，確保自完整的產品設計及全面品保系統和精密的檢驗儀器。從原料的入廠到製成品的包裝付運，都建立一貫作業的品質系統供各單位據以執行。春雨並通過國際ISO、TS、AS、EN歐盟建築產品指令、美國實驗室品質認證和IRIS國際鐵道系統認證合格，這是春雨自身對品質的要求與實現對客戶的承諾與保證。

Our total quality control system works throughout the whole production process from raw materials till finished goods. Furthermore, Chun Yu possessed of wide range of certifications approved by ISO, TS, AS, EN European Construction Products Directive (CE Marking), A2LA (American Association for Laboratory Accreditation) and IRIS (International Railway Industry Standard) certified. We believe that successfully maintain stable and superior quality goods will generate success for both our customers and Chun Yu over the long term.

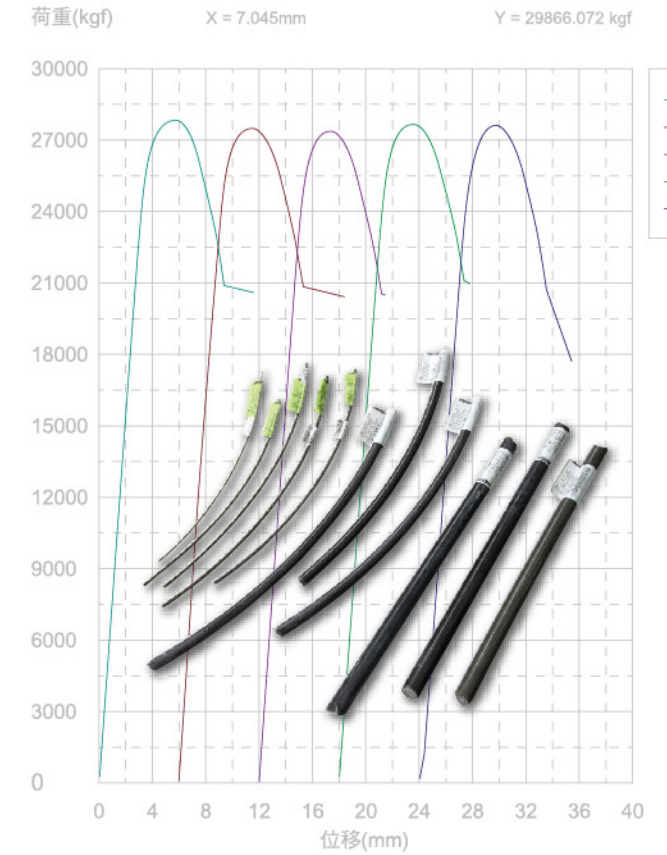

螺絲螺帽雙功能自動分析系統
 Multifunction nut and bolt torque / Tension testing system

3D量測儀
 3D measure machine

分光儀
 Optical emission spectrometer

100噸萬能試驗機
 Universal Testing Machine(100T)

2D量測儀
 2D measure machine

維克氏硬度試驗機
 Vickers Hardness Tester



QUALITY



INSPECTION EQUIPMENT 品質檢驗設備

品質保證
QUALITY ASSURANCE

設備類別 CATEGORY 儀器名稱 NAME	化性分析設備 CHEMICAL ANALYSIS EQUIPMENT	尺寸量測儀器 DIMENSIONAL MEASURE INSTRUMENT	深度規 Q Gauge 寬度規 P Gauge 環規 Ring Gauge 栓規 Plug Gauge 多功能校正器 Multifunction calibrator	鉛筆式硬度計 Pencil Hardness Tester
	PH計 PH Gauge 分光儀 Optical Emission Spectrometer	三針測定器 Three Wire Gauge 頭部厚度規 Head Thickness Gauge 滾軸式外牙紋測定器 Johnson Gauge 槓桿千分表 Magnetic Stands 投影測定機 Profile Projector 彎曲度試驗機 Straightness Gauge 同心度量規 Punch Gauge 高度計 Digit Height Gauge 游標卡尺 Caliper 分厘卡 Microment 2D量測儀 Quick Image 2.5D量測儀 Vision System 3D量測儀 Coordinate Measuring Machine	其他性能檢驗設備 OTHER PERFORMANCE TESTER 軸力計 Bolt Tension Meter 扭矩試驗機 Bolt Tension Testing Machine 鹽霧試驗機 Salt Spray Testing Machine 攻速試驗機 Drilling Testing Machine 破裂強度試驗機 Bursting Strength Tester 往復式彎曲試驗機 Instruments for The Measurement of Surface 觸針式表面粗糙度測定儀 Roughness by The Stylus Method 磁粒探傷儀 Magnetic Particle Crack Detector TC鎖斷槍 TC Tighten Tool X-Ray螢光膜厚儀 Coating Thickness Measurement	其他檢驗輔助設備 OTHER TESTER SUPPORTING FACILITIES 切割機 Cutter Full Automatic 鑲埋機 Mounting Press Machine 研磨拋光機 Lapping Polish Machine 微電腦可程式溫度控制爐 Microprocessor Programmable Temperature Control Furnace 植焊機 Stud Weld Machine
	機械性質試驗設備 MECHANICAL TESTER 拉力 Tensional →萬能試驗機 Universal Testing Machine 扭力 Torque →扭力扳手 Torque Wrench →扭力分析器 Torque Meter 硬度 Hardness →全自動硬度計 Automatic Hardness Tester →微小硬度計 Micro Hardness Tester →維克氏硬度計 Vickers Hardness Tester			
	金相組織檢驗設備 MICRO VIEWER 金相顯微鏡 Micro Scope 實體顯微鏡 Tereo Micro Scope			



WORLDWIDE DISTRIBUTION AND END USERS 客戶與終端使用群

客戶群
CUSTOMER

春雨公司產品透過全球銷售網行銷，至今擁有國內市場30%的佔有率，外銷客戶遍佈世界五十餘國。我們的產品多樣、應用廣泛，品質經嚴格把關，受到國內外製造業大廠的肯定。我們期盼能與您發展為一體的事業夥伴，共創互惠和互信的長期合作關係，取得雙贏的未來。

Through our global sales networks, Chun Yu has 30% of domestic market share and exports the products to more than 60 countries worldwide. Our quality and wide range of product applications have favored by many international manufacturers. We are looking forward to be part of your business and long term cooperate relationship to create mutual wins future.





台北101大樓
Taipei 101 Building

CHUN YU CONNECTS YOUR LIFE

春雨無所不在

客戶實績 ACHIEVEMENT

本公司產品品質及功能深受國內外客戶信賴，從建築極致的台北101大樓、宗教美學的中台禪寺、工程力學表現的斜張橋、安全要求嚴格的台灣高鐵、捷運以及國外核電廠、大型體育場館，皆有採用本公司產品。

Chun Yu's products are highly reliable. Our quality products are approved and trusted by many customers worldwide such as Taipei 101 building, Chun-Tai-Chan-Monastery, Cable-Stayed Bridges, Taiwan High Speed Rail, Taiwan MRT of Taipei and Kaohsiung, Taiwan Rail, Nuclear Energy Plants, World Stadium and Olympic Arenas.



高屏溪斜張橋
Cable-Stayed Bridge

興達火力發電廠
Thermal Power Plant



台北捷運
Taipei MRT

台灣高鐵
Taiwan High Speed Rail



中台禪寺
Chung-Tai-Chan-Monastery

台北小巨蛋
Taipei Arena





LION'S PASSION & AMBITION

用心經營的螺絲雄獅

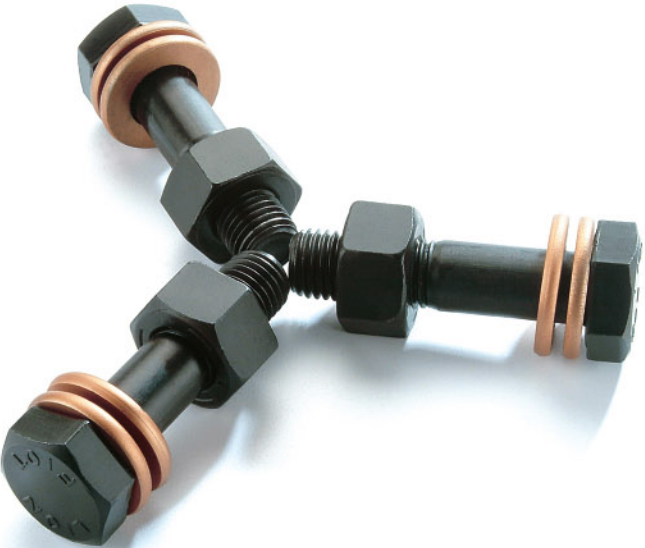

公司簡介 COMPANY PROFILE

春雨集團於1949年創立於高雄岡山鎮，最初生產縫衣針及計量器，旋即開始製造鐵板沖壓螺帽，1955年開始採多角化經營方式，擴充機器設備，生產各種螺絲、螺帽、六角孔螺絲及磨光棒等產品。回顧六十多年來，在全體員工的同心協力下，使春雨集團得以不斷成長茁壯。關係企業遍及台灣、印尼、美國及中國大陸，我們始終秉持著「創造、效益、服務」的經營理念，加強技術與品質的提升，使雄獅牌產品廣受國內外各界肯定，行銷全球且連年獲得外銷績優廠商獎勵與勞資和諧優良事業單位之表揚。緬懷創業維艱、守成不易，春雨集團將永續經營，提供最具有競爭力的優良產品回饋您明智的選擇。

In 1949, Mr. Chun-Yu Lee established "Chun Yu Works" which produced sewing nails, meters, and steel pressing nuts in Kangshan Town, Kaohsiung. Chun Yu expanded production machines and started producing bolts, nuts, hex socket screws, and steel bar etc. in 1955. Over the past 60 years, the constant growth of Chun Yu Group relies on the cooperation of all our employees. Our operation networks and manufacturing plants located in Taiwan, Indonesia, the United States and China. We are keeping "Creation, Efficiency and Services" as our Business Philosophy which enforce us to enhance quality and strengthen the technical level. We will keep our goal for permanence and provide the most competitive products and services to feedback your wisely choice.



CHUN YU FACTS

基本資料

公司簡介 COMPANY PROFILE

公司全名：春雨工廠股份有限公司
 成立時間：1949年12月
 上市時間：1991年10月17日
 資本額：新台幣28億7774萬元
 員工人數：500人(春雨台灣企業總部)
 2,000人(春雨集團)

研發人員：27人
 廠房面積：9,000坪(嘉興廠)
 55,000坪(企業總部)

集團總裁：林輝政
 集團執行長：李明晃
 企業總部：82063高雄市岡山區大寶街100號
 集團營運範圍：台灣、中國、印尼、美國

Company Name: Chun Yu Works & Co., Ltd.
 Founded: December, 1949
 Publicization: 17th October, 1991
 Capital: US\$ 96 Million (NT\$ 2.87 Billion)
 Employees: 500 (Chun Yu Taiwan)
 2,000 (Chun Yu Group)
 R&D: 27
 Area: Chiashing Plant 30,000 m² (323,000Ft²)
 Headquarter 182,000 m² (1,958,000Ft²)
 Chairman: Mr. Hwei-Jeng Lin
 CEO: Mr. Simon Lee
 Headquarter: No. 100 Tapao St., Kangshan, Kaohsiung 82063, Taiwan
 Global Operation: Taiwan, China, Indonesia, USA

CREATION, EFFICIENCY AND SERVICES

創造 · 效益 · 服務

組織架構圖
ORGANIZATIONAL CHART

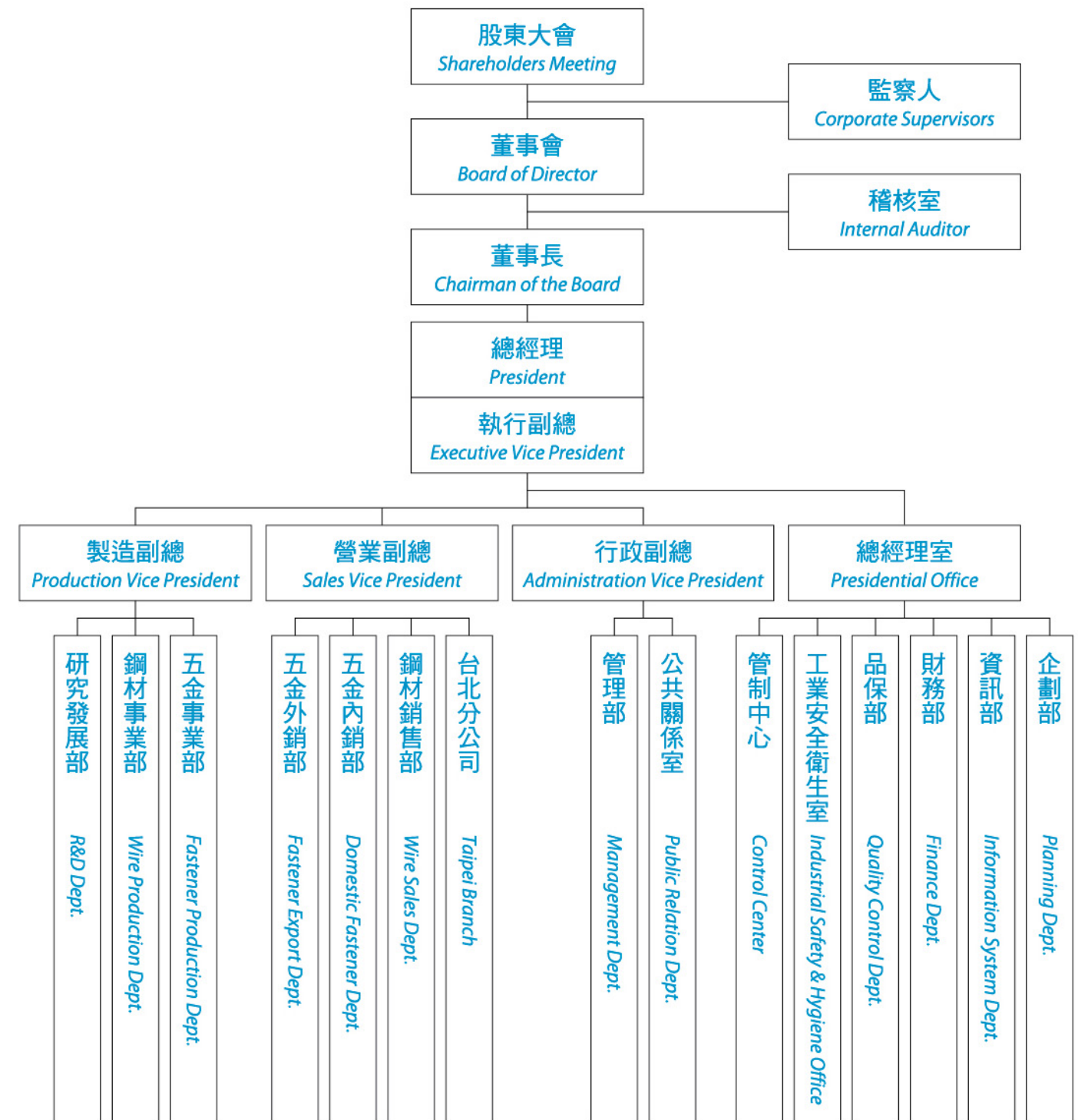



春雨(鞍山)五金制品有限公司
Chun Yu (Anshan) Metal Products Co., Ltd.

SUBSIDIARIES & AFFILIATES

關係企業

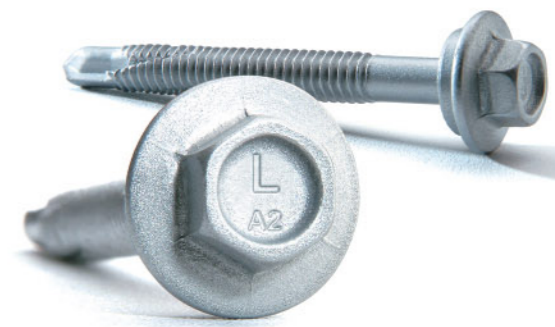

春雨公司關係企業

THE CHUN YU CHAIN INCLUDES

- 春日機械工業股份有限公司
- 上海春日機械有限公司
- 春邦貿易股份有限公司
- 春雨生醫股份有限公司
- 春雨(東莞)五金制品有限公司
- 春雨(鞍山)五金制品有限公司
- 上海友鉅五金制品有限公司
- 上海統盛貿易有限公司
- 春雨工廠美國公司
- 印尼雄獅工業股份有限公司

- Chun Zu Machinery Industry Co., Ltd.
- Shanghai Chun Zu Machinery Industry Co., Ltd.
- Hi-ace Trading Co., Ltd.
- Chun Yu Bio-tech Co., Ltd.
- Chun Yu (Dongguan) Metal Products Co., Ltd.
- Chun Yu (Anshan) Metal Products Co., Ltd.
- Shanghai Uchee Hardware Products Co., Ltd.
- Shanghai Tongsheng Trading Co., Ltd.
- Chun Yu Works (U.S.A.) Inc.
- Pt. Moon Lion Industries Indonesia



春雨(東莞)五金制品有限公司
Chun Yu (Dongguan) Metal Products Co., Ltd.
<http://www.chunyu.com.cn/>

上海春日機械有限公司
Shanghai Chun Zu Machinery Industry Co., Ltd.
<http://www.chunzu.com.cn/>

春日機械工業股份有限公司
Chun Zu Machinery Industry Co., Ltd.
<http://www.chunzu.com.tw/>

春雨(鞍山)五金制品有限公司
Chun Yu (Anshan) Metal Products Co., Ltd.

春雨工廠美國公司
Chun Yu Works (U.S.A.) Inc.
<http://www.cywusa.com>

上海友鉅五金制品有限公司
Shanghai Uchee Hardware Products Co., Ltd.
<http://www.uchee.com.cn/>

印尼雄獅工業股份有限公司
Pt. Moon Lion Industries Indonesia





SIGNIFICANT EVENTS

公司沿革

- 1949 前李董事長春雨昆仲創設「春雨工廠」於岡山鎮嘉峰里，製造縫衣針、計量器及鐵板沖壓螺帽。
- 1955 擴充機器設備，採多角經營，生產各種螺絲、螺帽、六角承孔螺絲、磨光鋼棒等產品。
- 1965 改組為「春雨工廠股份有限公司」資本額參佰萬元整。
- 1971 雄獅牌LION獲外銷新產品展覽特優獎。
- 1972 投資印尼，成立「印尼雄獅工業股份有限公司」，生產螺絲、螺帽等。
- 1974 轉投資機械業，成立「春日機械工業股份有限公司」生產各種螺絲、螺帽專用機械、牙板以及模具等。
- 1979 開始使用電腦，展開電腦輔助生產管理里程。
- 1980 投資成立「春邦貿易股份有限公司」。
成立春雨人聯誼會
- 1983 9月19日創辦人李春雨先生不幸積勞成疾與世長辭。
- 1986 引進日本「連續輻射管式線材球狀化熱處理爐」，生產球化退火鋼鐵線材，擴大產品線。
12月14日岡山廠落成啟用。
- 1987 投資線材加工業，成立「春聚工廠股份有限公司」。
- 1991 申請股票上市，10月17日於鋼鐵第一類股掛牌上市。
- 1993 元月投資設立春雨工廠美國公司
- 1995 8月在美國成立金屬粉末射出成型研發中心。
11月獲得德國RWTÜV ISO 9002認可登錄。
- 1996 元月取得經濟部投審會正式核准大陸廣東東莞投資案，並成立士高樂控股有限公司。
- 1998 4月「春雨(東莞)五金制品有限公司」正式開幕。
4月獲得美國A2LA實驗室認可。
7月成立「上海統盛貿易有限公司」。
11月成立春展、喬新、富登投資股份有限公司。
12月成立「美國富大科技股份有限公司」，生產金屬射出成型產品。
- 1999 10月取得QS-9000品質系統認證。
- 2000 1月獲得ISO-14001環境管理制度認證合格。

- 2001 1月正式啟用電子表單及品質檢驗資料庫，邁入公文E化及無紙化。
- 2003 10月31日獲頒ISO/TS16949認證證書。
- 2006 4月8日獲得AS9100認可登錄。
9月25日獲得工研院航太產品合格證明書。
- 2008 1月10日成立「春雨生醫股份有限公司」。
- 2009 5月獲得OHSAS18001 & TOSHMS職業安全衛生管理系統認證合格。
9月取得FPC新加坡建築產品驗證合格證書。
12月18日取得IRIS認證證書，成為全亞太唯一且第一家取得國際IRIS鐵道認證之緊固件製造商，台灣第一家取得IRIS鐵道認證的專業製造廠。
發展攻牙鏈帶螺絲，增加產品附加價值。
- 2010 7月獲得台灣德國萊茵TUV CE產品(EN14566乾牆螺絲及EN13918剪力釘)等產品之驗證合格證明書。
7月獲得德國TUV Rheinland歐盟建築指令CE產品(EN14399-1HR. HV. HRC等系統及EN15048-1)等產品驗證合格證明書。
3月31日春雨生醫合併春聚工廠，正式跨足醫療器材製造產業。
投資成立春雨(鞍山)五金製品有限公司，目標瞄準大陸內需及東南亞市場。
- 2011 購置懸臂式球化爐，提升球化線材品質。
- 2012 以鏈帶槍搭配鏈帶螺絲銷售，朝複合件銷售方向邁進。
引進輻射組機台，提升小線競爭力。
興建春雨集團企業總部大樓。
12月本集團「春日機械工業(股)公司」登錄為股票興櫃公司。
- 2013 「春雨(東莞)五金制品有限公司」獲得CE、ROHS及CNAS國家實驗室等認證，高強度螺絲產品更榮獲廣東省品質技術監督局頒發「廣東省名牌產品稱號」證書。
4月春雨集團企業總部大樓啟用，嘉興、岡山二廠廠辦合一。

- 1949 Mr. Chun-Yu Lee established "Chun Yu Works" produced sewing nails, meters, and steel pressing nuts in Kaohsiung, Kangshan
- 1955 Expanded production machines and produces bolts, nuts, hex socket screws, and steel bar
- 1965 Restructured to "Chun Yu Works & Co., Ltd." on 27th March and increased the capital to 3 million NTD
- 1971 LION awarded with superior brand
- 1972 Established "P.T. Moon Lion Industries Indonesia" which produces bolts and nuts
- 1974 Invested machinery industry and established "Chun Zu Machinery Ind. Co., Ltd." which produces bolts, nuts, and screws production machines, also threaded plate, and tooling dies etc.
- 1979 Adopted electronic system in production control process
- 1980 Established "Hi-Ace Trading Co., Ltd."
Established "Chun Yu Society"
- 1983 Mr. Chun-Yu Lee passed away on 19th September
- 1986 Imported Continuous Type Spheroidizing Annealing Furnace from Japan
Kangshan Plant Established on 14th December
- 1987 Invested wire processing industry and established "Wire Master Works & Co., Ltd"
- 1991 Chun Yu became publicized on 17th October
- 1993 Established "Chun Yu Works (U.S.A) Inc." in January
- 1995 Established Metal Injection Molding R&D Institute in August in Chicago USA
Award RWTÜV ISO 9002 Quality Management System Certificate in November
- 1996 Approved by Ministry of Economic Affairs, R.O.C to invest in Dongkuan, Guangdong province, China
- 1998 Established "Chun Yu (DongGuan) Metal Products Co., Ltd." in April
Awarded with A2LA Laboratory Certificate in April
Established "Shanghai Tongsheng Trading Co., Ltd" in July
Established "Chun Chan", "Cho Shin", "Photon Formosa Co., Ltd." in November
Established "Fu Da Tech Co., Ltd" in December, which produces Metal Injection Molding products
- 1999 Awarded with SGS QS 9000 Quality Management System Certificate in October
- 2000 Awarded with SGS ISO 14001 Environmental Management System Certificate in January
- 2001 Electronic forms and quality inspection database formally used in January
- 2003 Awarded with SGS ISO/TS 16949 Quality Management System Certificate on 31st October
- 2006 Awarded with AS9100 Quality Management System Certificate on 8th April

- Awarded with Aerospace Fastener Approval certificate on 25th September
- 2008 Established Chun Yu Bio-Tech Co., Ltd. on 10th January
- 2009 Awarded with SGS OHSAS18001 & TOSHMS Occupational Safety and Health Management System Certificate in May
Awarded with Factory Production Control (FPC) of Singapore Construction Products Certification in September
Awarded with International Railway Industry Standard (IRIS) Certification on 18th December, became the first fastener manufacturer who acquired IRIS Certification in Asia-Pacific and the first professional manufacturer in Taiwan with IRIS Standard Certified
Developed "Collated Screw" of tapping and self-drilling screw, provides value-added towards products.
- 2010 Awarded with TUV CE Marking (EN14566 Gypsum Plasterboard System and EN13918 Welding Stud) Product Certification certified in July.
Awarded with German TUV Rheinland EN European Construction Products Directive, CE Marking Products (EN14399-1HR. HV. HRC High-strength structural bolting assemblies for preloading and EN15048-1 Non-preloaded structural bolting assemblies) Certification certified.
Wire Master Works merged with Chun Yu Bio-tech Corp. and officially engaged in medical equipment manufacturing business from 31st March.
Invested and established Chun Yu (Anshan) Metal Products Co., Ltd. which targeted the domestic market demand in China and the Southeast Asia markets.
- 2011 Purchased the Pit Type Spheroidizing Annealing Furnace to upgrade the quality of annealing wire rods.
- 2012 Promoting the Collated Screw together with Collated Autofeed Screwdriver system and moving towards marketing integration.
Introduced and equipped High Speed Straight Line Type Wire Drawing Machine for Roller Cassette to enhance competitiveness over the wire.
Constructed the Chun Yu Group Headquarter Building.
"Chun Zu Machinery Ind. Co., Ltd." has registered as Public Company in December.
- 2013 "Chun Yu (DongGuan) Metal Products Co., Ltd." has obtained the CE, ROHS and CNAS National Laboratory Certificates. The high strength bolt also awarded with "Guangdong Province Famous Brand" certificate by Guangdong Provincial Quality and Technical Supervision Bureau.
The Chun Yu Group Headquarter Building moved in in April.
The Chiashing and Kangshan Plant Office Unity.